

# Technology to Inspire Innovation



## Connector Selection Guide 2014

# Board-to-Board Connectors

Series	WP3	WP6/C	WP7	WP9	WH1	AA01A	WR	KX14/15	KX24/25	TX24/25
Photo										
Pitch	0.4mm	0.4mm	0.4mm	0.4mm	0.4mm	0.5mm	0.5mm	0.8mm	0.8mm	1.27mm
Stacking Heights	1.0mm	0.8mm	0.7mm	0.8mm	1.0mm	1.5mm	4.0, 4.5, 5.0, 5.5, 6.0, 6.5, 7.0, 8.0, 9.0mm	5.0, 6.0, 8.0, 9.0, 11.0, 12.0mm	N/A	12.0-24.0mm (±2.0mm)
Pin Count (Parallel)	16,20,22,24, 30,36,40,42, 50, 64,70,80	10,12,16,20, 24,30,40,50	10,16,20,24, 26,28,30,32, 34,40,50,70	10,14,20,24, 30,32,40,60	24,30,40, 50,60	10,30,40,60	20,30,40,50, 60,70,80,100, 120,160	20,30,40,50, 60,70,80	80,100,120, 140,180 (coplanar)	30,40,50, 60, 80,100,120
Pin Count (Right Angle)	N/A	N/A	N/A	N/A	N/A	N/A	30,40,50,60, 70,80,120	20,30,40,50, 60,70,80	80,100,120, 140,180	30,40,44,50, 60,80,100,120
Board Mount	SMT	SMT	SMT	SMT	SMT	SMT	SMT	SMT	Thru-hole	Thru-hole
Current Rating	0.4A	0.3A	0.2A	0.3A	0.4A	0.2A	0.3A	0.5A	0.5A	1.0A
Voltage Rating	50VAC 50VDC	50VAC 50VDC	50VAC 50VDC	50VAC 50VDC	50VAC 50VDC	50VAC 50VDC	200VAC 300VDC	200VAC 300VDC	200VAC	250VAC
Durability	50 cycles	30 cycles	30 cycles	50 cycles	50 cycles	30 cycles	500 cycles	500 cycles	500 cycles	500 cycles
Features	High retention force.	Shielded variation available for 24 and 30 position with common footprint.	High retention force for low pin counts and low insertion force for high pin counts.	Small connector width helps reduce board mounting space.	Two point contact to resist twisting stress.	Dual mating contact.	9 different vertical stack heights.	Mating guide and key to prevent mis-mating.	Robust mating guide. Click response when mated.	Ribbon type contacts ensure reliable electrical continuity.

Socket side: **WP3 - S###VA1 - R6000**  
 Pin side: **WP3 - P###VA1 - R6000**

Orderable in Reels of 6000

Socket side: **WP6 - S###VA2 - R6000**  
 Pin side: **WP6 - P###VA2 - R6000**

Shielded version:

Socket side: **WP6C - S###VA1 - R6000**  
 Pin side: **WP6C - P###VA1 - R6000**

Orderable in Reels of 6000

For pin counts up to 32:

Socket side: **WP7A - S###VA1 - R6000**  
 Pin side: **WP7 - P###VA1 - R6000**

For pin counts above 32:

Socket side: **WP7B - S###VA1 - R6000**  
 Pin side: **WP7B - P###VA1 - R6000**

Orderable in Reels of 6000

Socket side: **WP9 - S###VA1 - R6000**  
 Pin side: **WP9 - P###VA1 - R6000**

Orderable in Reels of 6000

Socket side: **WH1S###WA1-E6000**  
 Pin side: **WH1P###WA1-E6000**

Orderable in Reels of 6000

Socket side: **AA01A-S###VA1-R3000**  
 Pin side: **AA01A-P###VA1-R3000**

Orderable in Reels of 3000

Socket side: **WR - ###S - VF - N1**

B: Positioning Boss ———— H05: +0.5mm  
 H30: +3.0mm

Vert Pin side: **WR - ###P - VF - N1**

B: Positioning Boss ———— 50: +1.0mm  
 60: +2.0mm

R/A Pin side: **WR - ###P - HF - HD - A1E**

Receptacle: **KX14 - ##K 2 DE**

Stack Height:  
 2, 5, 8mm

Straight Plug: **KX15 - ##K 3 DE**

Stack Height:  
 2, 3, 4mm

R/A Plug: **KX15 - ##K L DLE**

Right angle



Receptacle: **KX24 - ###R - LT - H1**  
 Plug: **KX25 - ###P - LT - H1**

LT: Right-angle ———— H: Hook pin  
 6ST: Straight

Receptacle: **TX24 - ###R - LT - H1E**  
 Plug: **TX25 - ###P - LT - H1E**

Stacking Height: ———— H: Hook pin  
 Receptacle: N: No hook pin  
 6, 10, 12mm  
 Plug: LT: Right angle  
 6, 8, 12mm ST: Straight  
 \*Right-angle leave blank

# Input/Output Connectors

Series	DC2	DC3	DD4	DD1	DD2	DP3	DX4	DC1
Photo								
Pitch	0.4mm	0.4 mm	0.4mm	0.5mm	0.5mm	0.6mm	0.65mm	1.0mm
I/O	Cable I/O	Cable I/O	Cable I/O R/A Dock Vert Dock	Cable I/O R/A Dock 75° Vert Dock	Cable I/O R/A Dock Vert Dock	Cable I/O	Cable I/O	Cable I/O
Pin Count	19	19	40	30	40	20	5	19
Signal Standard	HDMI	HDMI	USB 3.0 DisplayPort™ SATA	USB 2.0	USB 2.0	Thunderbolt™	USB 2.0	HDMI
Current Rating	0.5A	0.3A	Signal: 0.1A Power: 1.1A	Signal: 0.5A Power: 1.0A	Signal: 0.5A Power: 1.0A	Signal: 0.5A	Signal: 0.5A Power: 1.8A	0.5A
Voltage Rating	40VAC	40VAC	30VAC	30VAC	30VAC	300VAC	30VAC	40VAC
Durability	5,000 cycles	5,000 cycles	5,000 cycles	10,000 cycles	10,000 cycles	10,000 cycles	10,000 cycles	10,000 cycles
Operating Temp	-20 ~ +85 °C	-20 ~ +85 °C	-25 ~ +75 °C	-25 ~ +75 °C	-25 ~ +75 °C	-20 ~ +85 °C	-30 ~ +80 °C	-20 ~ +85 °C
Locking	Friction	Friction	Friction	Latch	Latch	Friction	Friction	Friction
Features	Mini HDMI Type C compatible. Requires HDMI adopter status.	Micro HDMI Type D compatible. Requires HDMI adopter status.	Space-saving low height, fine pitch docking connector.	Docking connector to combine various high speed signals in a single connector.	Robust and compact design. Compatible with high speed signaling.	Thunderbolt™ compatible. Various board mounting options available.	Micro USB 2.0 standard compatible. Various mounting options available.	HDMI Type A compatible. Requires HDMI adopter status.

Receptacle: **DC1RS19JA7**

Cable Harness: **DC1P019ST30200B**

Restricted to HDMI Adapters  
Contact JAE for additional options

Receptacle: **DC2R019JA4**

Hold Down Type — Modification code  
J: T/H, H: SMT

Cable Harness: **DC1DC2ST2150B**

Restricted to HDMI Adapters  
Contact JAE for additional options

Receptacle: **DC3RX19JA2**  
Top Mount

Modification Code  
Hold Down Type  
X, J: T/H  
0, H: SMT

Receptacle: **DC3R019JA1**  
Mid Mount

Modification Code

Restricted to HDMI Adapters  
Contact JAE for additional options

Receptacle: **DD1R030HA1** Standard mount  
**DD1R030JA7** Reverse mount

Docking Plug: **DD1B030VA1** Vertical  
**DD1B030HA1** Right angle

Cable Plug: **DD1P030MA1**

Receptacle: **DD2R040HP2**

Docking Plug: **DD2B040VP4** Vertical  
**DD2B040HA2** Right angle

Cable Plug: **DD2P040MA1**

Receptacle: **DP3R020S U32JQ 1 R400**

Board Mount Type — T/H lead length  
S: Standard Blank: 1.4mm  
R: Reverse 1: 2.1mm

Height modification code —  
U32: 3.2mm up  
L05: 0.5mm down

Receptacle: **DD4RA040JA1**



Docking Plug: **DD4PA040WA1** Vertical  
**DD4PA040MA1** Right angle

Cradle: **DD4BA040WA1**  
**DD4BA040MA1**

Receptacle: **DX4R005 J J 2**

Modification Code — Modification Code  
Hold Down Type —  
J: T/H  
H: SMT

# Board-to-FPC Connectors

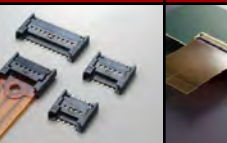
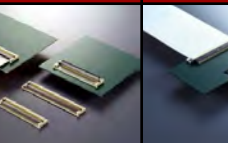
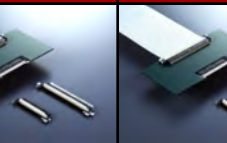
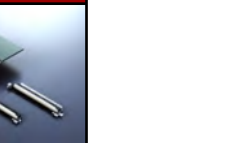
Series	FF08	FR02	FB10	FA10	FF03	FA5B	FA5S
Photo							
Pitch	0.2mm	0.2mm	0.3mm	0.5mm	0.5mm	0.5mm	0.5mm
Mounted Height	1.0mm	0.82mm	0.9mm	0.9mm	2mm	1.0mm	1.45mm
FPC/FFC Thickness	0.15±0.03mm	0.2±0.03mm	0.2±0.03mm	0.2±0.03mm	0.3±0.05mm	0.3±0.05mm 0.14±0.03mm	0.3±0.05mm
FPC Contact Orientation	Lower	Upper & Lower	Lower	Upper & Lower	Lower	Lower	Lower
Pin Count	25,29,41,51,71,81	51,61	13,15,21,27,31, 33,41,45,51,61	4,5,6,8*,10*	60,64,68,80,96	6,8,10,16,20, 30,36,40,45,50	6,8,10,15,16, 18,20,22,24, 26,30,36,40, 45,50
Current Rating	0.3A	0.25A	0.35A	0.5A	0.5A	0.8A	0.8A
Voltage Rating	50V	50V	50V	50V	50V	50V	50V
Features	Smallest pitch. Rotating actuator.	Lowest profile in class. Robust rear actuator.	Smallest PCB footprint. Easy actuator operation.	Quick one-step insertion & removal. Requires no actuator operation.	Highest pin count.	Mid mount type for low profile applications.	Easy slider operation.

Loose pcs: **FA5B0##HP1**

Reel: **FA5B0##HP1 R3000**

1: t0.3mm FPC/FFC  
3: t0.14mm FPC/FFC

Reel: **FB10S###JA2R6000**

Loose pcs: **FF03##SA1**

Reel: **FF03##SA1 - R2000**

Loose pcs: **FA5S0##HP1**

Reel: **FA5S0##HP1R3000**

Loose pcs: **FR02C0##JA1**

Reel: **FR02C0##JA1-R5000**

Reel: **FF08##SA1-R3000**

Loose pcs: **FA10##SA1**

Reel: **FA10##SA1-R8000**





# Board-to-Cable Connectors

Series	FI-JP	FI-JW	HJ1	HD1/FI-Z	FI-R	FI-X	FI (single row)	FI (dual row)
Photo								
Pitch	0.25mm	0.3mm	0.4mm	0.5mm	0.5mm	1.0mm	1.25mm	1.25mm
Discrete Wire AWG	N/A	N/A	#34,36	#32,34,36	#30,32,36	#30,32,36	#28,30,32	#28,30,32
Coax Wire AWG	#44,46	#42,44	#36,38,40,42,44	#36,38,40,42,44	#40	#32,40	N/A	N/A
FPC/FFC	N/A	N/A	N/A	N/A	FFC (JF08)	0.14±0.03mm	0.14±0.03mm	N/A
Pin Count	40,50	30, 34,40, 50	50	40	21,31,41,51	30	2-6,8,10,15, 20, 25,30	5,7,9,11,13, 15,17,19,21, 31,41
R/A Height	1.08mm	1.65mm	0.9mm	1.0mm	3.8mm	1.0-2.35mm	1.8mm	3.7mm
Locking	Friction	Friction	Friction/ pull bar	Friction/ pull bar	Latches	Latches	Friction	Friction
Durability	20 cycles	30 cycles	30 cycles	30 cycles	50 cycles	50 cycles	50 cycles	50 cycles
Current Rating	0.2A	0.25A	0.1A to 1.0A	0.1A to 1.0A	0.8A	1.0A	1.0A	1.0A
Voltage Rating	50V	50V	100V	100V	200V	200V	200V	200V
Features	Vertical mating. Smallest pitch.	Vertical mating. Small footprint.	Ground reinforced design. Lowest profile.	Compatible with VESA standard for LED backlit wide panels. <small>LICENSED BY DAI-ICHI SEIKO CO., LTD. (I-PEX)</small>	VESA standard for LCD interface of HD TV. Vertical mount available.	VESA standard for 1.0mm pitch LVDS interface.	Single row for low profile.	Dual row for smaller footprint.



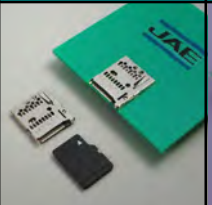
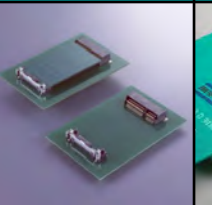
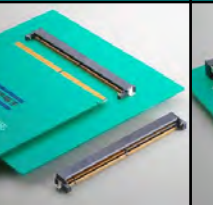
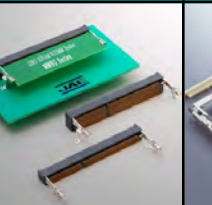
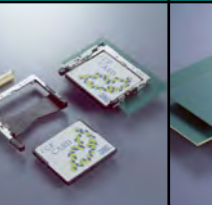
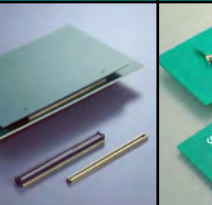

# Card Connectors 1 (microSD, CF, DIMM, PCIe, M.2)

Series	ST1/ST1-G/T	ST10	ST11	MM60	MM70	MM80	JC26/C2	WA6	SM3
Photo									
Card	microSD	microSD	microSD	PCI Express Mini Card	MXM 3.0 Graphics Card	DDR3 SDRAM SODIMM	CompactFlash	MicroDIMM	M.2
Mounted Height	1.9mm/1.4mm	1.25mm	1.25mm	2.125, 4.0, 5.9mm	4.3, 6.7mm	5.2, 9.2mm	5.8, 7.4mm	3.0mm	2.15, 3.1, 4.1mm
Pin Count	8, 8+2	8+2	8+2	52,76	314	204	50	214	67
Voltage Rating	10V	10V	10V	300V	250V	500V	10V	10V	300V
Current Rating	0.5A	0.5A	0.5A	0.5A	0.5A	0.3A	0.5A	0.3A	0.5A
Durability	10,000 cycles	10,000 cycles	5,000 cycles	50 cycles	30 cycles	25 cycles	10,000 cycles	25 cycles	60 cycles
Style	Hinged	Push-push	Push-push	Card Edge	Card Edge	Card Edge	Ejector	Board to Board	Card Edge
Features	Available with card detection switch. Smallest footprint & lowest height for hinged type.	Lowest height in the market.	Strong mechanical lock to prevent card from popping out from vibration and shock.	Retention latch or screw hold downs available to fix module to connector and main PCB.	MXM3.0 standard compatible. Available in 2 heights.	DDR3 SO-DIMM connector compatible w/ JEDEC standard MO-268C.	Reverse mount available. Retractable ejector available.	DDR2 MicroDIMM connector compatible with JEDEC Standard MO-260B SO-004A.	Multiple key and heights variations available.

MicroSD: **ST1W008S4 A R1500**  
 Hinged type  
 Modification code

MicroSD: **ST1W008S4 G R2000**  
 Low profile Hinged type  
 G: Without detect switch  
 T: With detect switch

Orderable in reels

MicroSD: **ST10S008V4BR1800**  
 Push-push type

Orderable in reels

MicroSD: **ST11S008V4HR2000**  
 Push-push type

Orderable in reels

PCI Express Mini Card

Connector : **MM60 - 52 - B 1 - E 1**  
 No. of contacts — 52  
 Socket type — B: Top mount, C: Mid mount  
 Key type — 1  
 Contact finish — E  
 Height modification code — 1

Latch : **MM60 - EZ - H059 - B 5**  
 Latch type — EZ  
 Connector height — H059  
 With boss — 5: Sn plating

Nut : **NT1R3000** 4.0mm height connector  
**NT4R1600** 5.9mm height connector

MXM 3.0 Graphics Card

Connector: **MM70- 314-310 B 2 - 1**  
 Height modification code — 1: 3.0mm, 2: 1.5mm  
 Contact finish: (Au plating) — 1: 0.1µm min., 2: 0.3µm min.

DDR3 SDRAM SO-DIMM

Connector: **MM80 - 204B1 - E1R**  
 Height modification code — 1: 5.2, E: 9.2  
 Blank: Standard  
 R: Reverse

CompactFlash

Connector: **JC26A - BB \* E**  
 Blank: Standard 16: +1.6mm

Frame: **JC26C2 - D S R \_ E**  
 D: Push-push ejector, F: Fixed ejector  
 S: Standard, R: Reversed  
 Blank: Standard 16: +1.6mm  
 R: Right, flip, L: Left, flip, M: Right, fixed, H: Left, fixed







DDR2 MicroDIMM

Female side: **WA6F214VA1T**  
 Male side: **WA6M214VA1T**

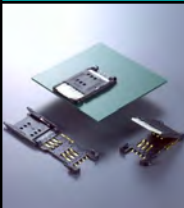
M.2 (NGFF)

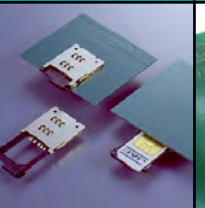
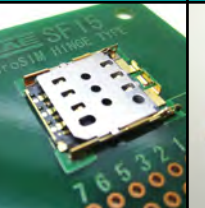
Connector: **SM3 Z S 067 U 310 \* \***  
 No. of contacts — 310  
 Mounting Type: On-board  
 Height: 215: 2.15mm, 310: 3.10mm, 410: 4.10mm  
 Polarizing key: A/B/E/M  
 Contact area finish: A: Au 0.13µm min., B: Au 0.25µm min.

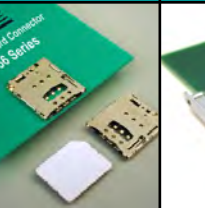
# Card Connectors 2 (SIM, micro SIM, nano SIM)

Series	SF7	SF8	SF9	SF15	SF50	SF51	SF56	SF58	SF70
Photo									
Card	SIM	SIM	SIM	Micro SIM	Micro SIM	Micro SIM	Micro SIM	Micro SIM	Nano SIM
Mounted Height	1.9, 2.25, 2.5mm	1.55mm	1.8mm	1.55mm	1.2mm	1.8mm	1.25mm	1.3mm	1.25mm
Pin Count	6, 6+2	6	6	6	6	6+2	6+2	6+2	6+2
Current Rating	10µA to 1A	10µA to 1A	10µA to 1A	0.5A	0.5A	0.5A	0.5A	0.5A	0.5A
Durability	5,000 cycles	5,000 cycles	5,000 cycles	1,500 cycles	5,000 cycles	1,000 cycles	5,000 cycles	5,000 cycles	5,000 cycles
Style	Hinged	Tray type	Tray type	Hinged	Pull bar	Tray type	Push-Push	Tray type	Tray type
Features	Locking structure. Positioning boss, metal cover, or detection switch available.	Lowest profile for tray type connector. Normal and reverse mount available.	Normal and reverse mount available. 5 hold downs for EMI and ESD prevention.	Small footprint and height. Clear click feeling to indicate when cover is locked.	Small height and footprint. Pull bar included to assist ejection of card.	Reverse mount. Unique lock design to increase tray retention strength without increasing eject force.	Smallest in class height. Card detect switch included.	Low profile & narrow design. Push-eject tray type with card detect switch included.	Compatible with 4FF nano SIM cards for compact portable devices. Includes tray detect switch.

SIM: **SF7W 006 S 1 A**

Hinge type connector

006: 6 position  
008: 6 signal + 2 switch

A: Positioning boss  
B: No boss  
E: Low profile

1: Standard  
4: Low profile

Micro SIM: **SF51S006V4BR1400**

Tray type

Please contact JAE for recommended dimensions of the tray.

Micro SIM: **SF15W006S4BR2000**

Hinge type

SIM: **SF8V006S4AR1200**

Tray type connector

A: Standard  
B: Reverse

Tray: **SF8-STS1-A** Standard  
**SF8-STR1-B** Reverse

**Need both Connector and Tray to use SF8 series**

Micro SIM: **SF50S006V4AR1500**

Pull bar type

A: Pull bar on left  
C: Pull bar on right

Micro SIM: **SF58S006VBAR2000**

Tray type

Please contact JAE for recommended dimensions of the tray.

SIM: **SF9W006S4AR1200**

Tray type connector

A: Standard  
B: Reverse

Tray: **SF9-STS1-A** Standard  
**SF9-STR1-B** Reverse

**Need both Connector and Tray to use SF9 series**

Micro SIM: **SF56S006V4AR2000**









Push-Push Type

Nano SIM: **SF70S006VBAR2000**

Tray type

Please contact JAE for recommended dimensions of the tray.

# Circular Connectors

Series	JB5	JB1	JN1 / JN2	JN1W / JN2W	SRCN	JL02	JL04V	JL05	N/MS
Photo									
Shell Size	Φ11.0mm	Φ18.0mm	Φ19.0mm	Φ26.2mm	Φ21.2-33.2mm	Φ34-62.7mm	Φ22-56.3mm	Φ36-51.7mm	Φ20-77mm
Pin Count	3, 4, 5, 6, 8	3, 5, 10	4, 10	5, 15	3,5,7,10,16,24	10, 17, 19, 24, 37, 48, 54	3, 4, 6, 7, 8, 9, 18, 22	4,5,7,8,9,10, 17,19,24,30, 36,37,52,73	1~11,14,16,17, 19,22,24,26,35, 37,48,54
Shell Material	Metal	Metal	JN1: Plastic JN2: Metal	JN1W: Plastic JN2W: Metal	Metal	Metal	Metal	Metal	Metal
Mated Condition	IP68	IP67	IP67	IP67	N/A	N/A	IP67	IP67	N/A
Current Rating	2 ~ 3A	3A	3 ~ 5A	3 ~ 13A	5 ~ 10A	1.5 ~ 3.0A	13 ~ 80A	5 ~ 46A	13 ~ 150A
Voltage Rating	200VAC ~ 320VAC	300VAC	200VAC	200VAC ~ 400VAC	250VAC ~ 350VDC	200VAC ~ 500VAC	100VAC ~ 500VAC	250VAC ~ 900VAC	200VAC ~ 3,000VAC
Durability	5,000 cycles	500 cycles	500 cycles	500 cycles	500 cycles	500 cycles	500 cycles	500 cycles	500 cycles
Lock	Push-pull	Threaded	Push and twist	Push and twist	Threaded	Threaded	Threaded	Bayonet	Threaded
Operating Temp	-55 ~ +85 °C	-30 ~ +85 °C	-20 ~ +125 °C	-20 ~ +125 °C	-25 ~ +85 °C	-55 ~ +85 °C	-55 ~ +125 °C	-55 ~ +125 °C	-55 ~ +125 °C
Wire Size	AWG #22-28	AWG #22-28	AWG #20-28	AWG #14-28	AWG #16-20	AWG #4-16	AWG #4-18	AWG #8-26	AWG #0-16
Termination	Solder	Crimp	Crimp / Solder	Crimp / Solder	Solder	Crimp	Solder	Crimp / Solder	Solder
Features	Small size. Unmated waterproof.	EMI Shielding	One-touch locking mechanism	One-touch locking mechanism	UL approved. 5 insert guide keys.	Mates with MIL-DTL-5015 standard.	TUV and UL approved	JIS B 6015 compatible.	UL approved. Mates with MIL-DTL-5015 standard.

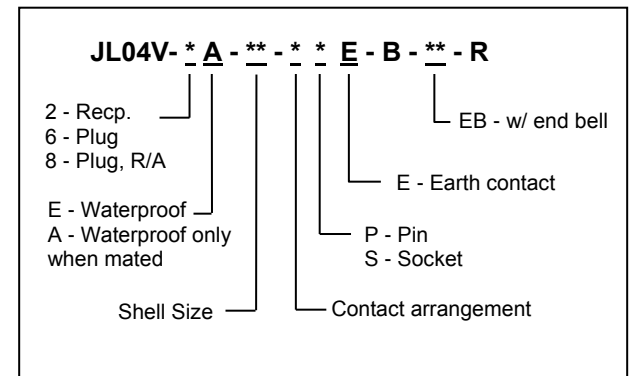
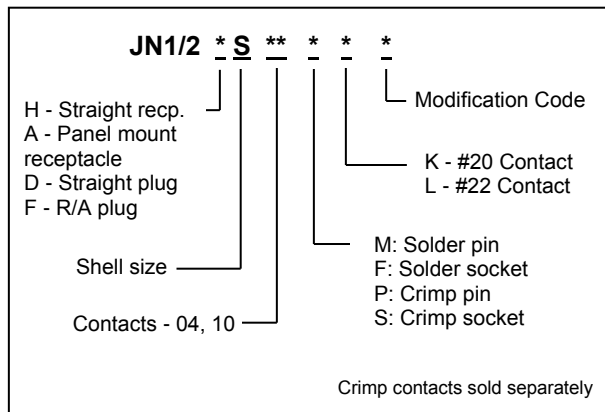
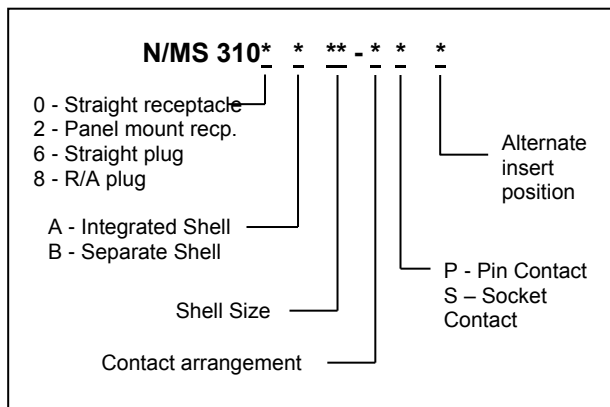
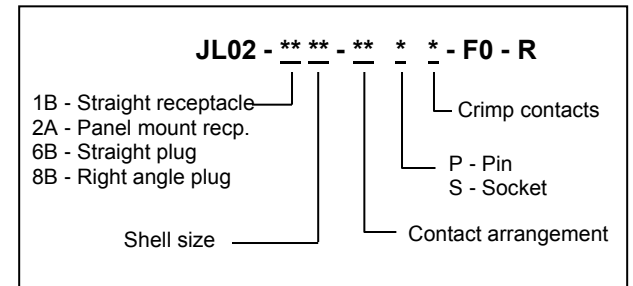
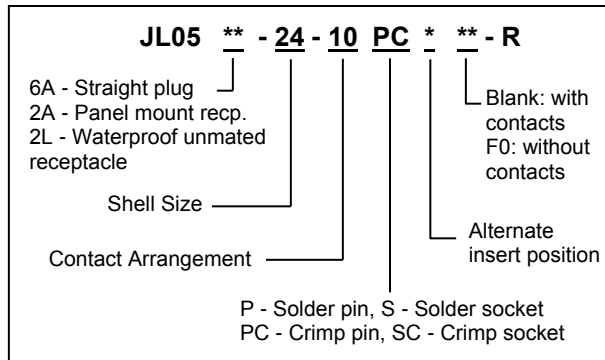
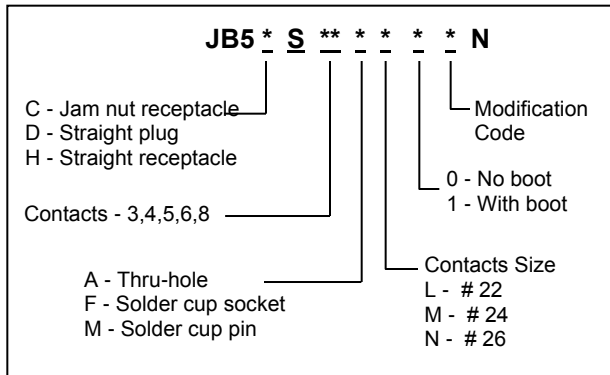
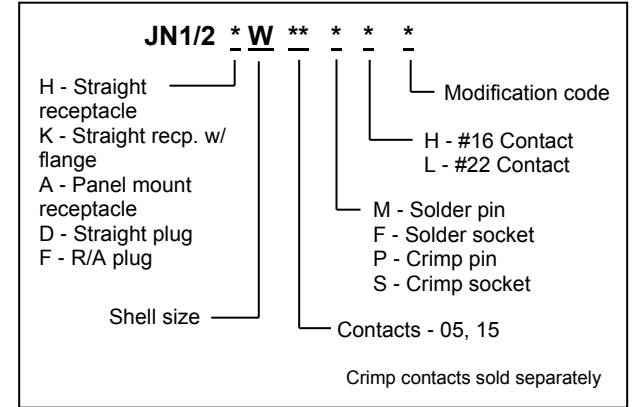
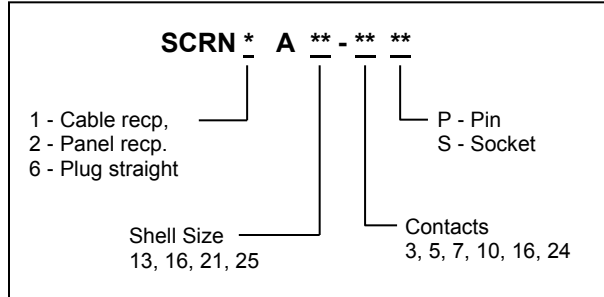
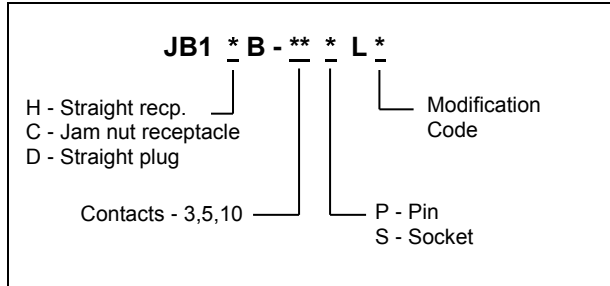





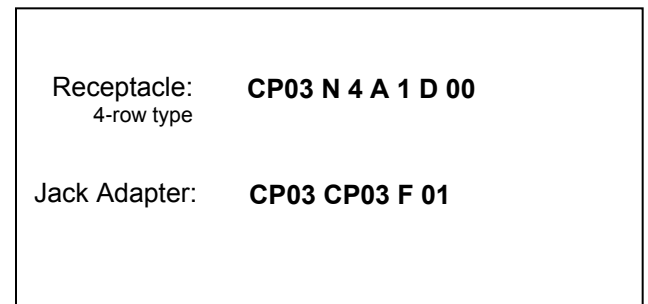
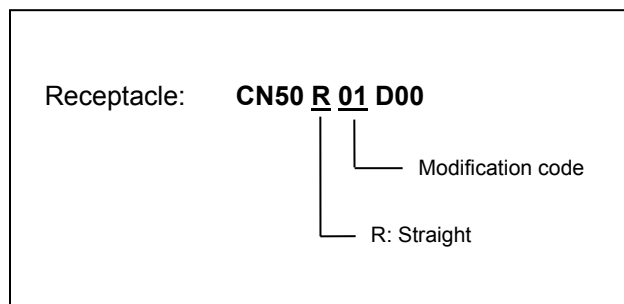
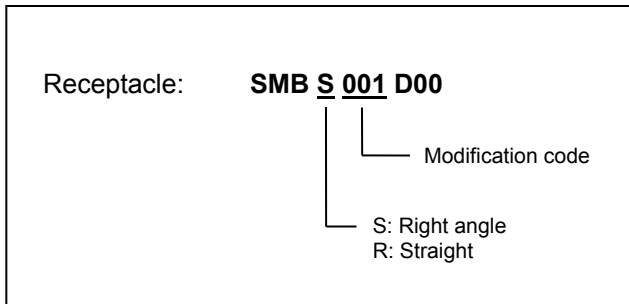
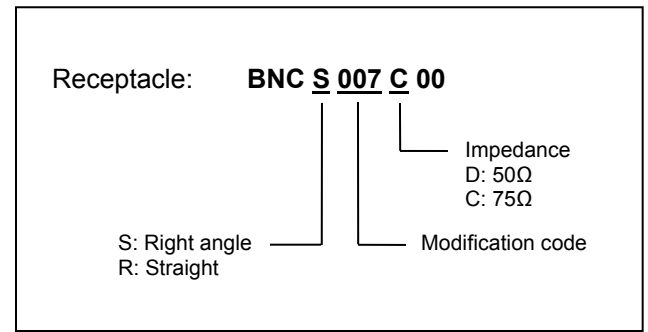
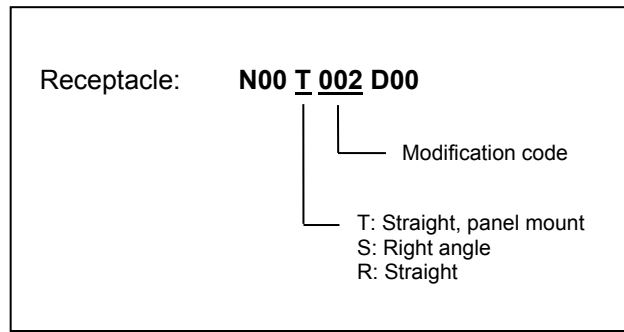
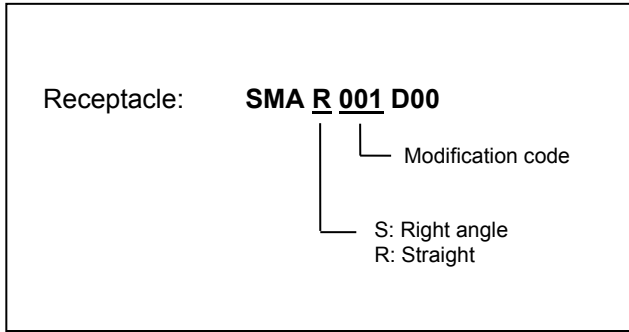

# RF Coaxial Connectors

Series	SMA	SMB	CN50	N	BNC	CP03
Photo						
Characteristic Impedance	50Ω	50Ω	50Ω	50Ω	50Ω / 75Ω	50Ω
Frequency Range	DC to 3GHz	DC to 3GHz	DC to 3GHz	DC to 3GHz	50: DC to 3GHz 75: DC to 1.5GHz	DC to 65GHz
VSWR	1.2	1.2	1.2	1.2	1.2	1.5
DW Voltage	500VAC rms (1 min)	500VAC rms (1min)	500VAC rms (1min)	500VAC rms (1min)	500VAC rms (1min)	500VAC rms (1min)
Contact Resistance	Center: 4mΩ Outer: 4mΩ	Center: 5mΩ Outer: 2.5mΩ	Center: 15mΩ Outer: 8mΩ	Center: 10mΩ Outer: 10mΩ	Center: 10mΩ Outer: 5mΩ	Center: 6mΩ Outer: 2mΩ
Insulation resistance	500MΩ min.	500MΩ min.	500MΩ min.	500MΩ min.	500MΩ min.	5,000MΩ
Operating Temperature	-40 ~ +85 °C	-40 ~ +85 °C	-40 ~ +85 °C	-40 ~ +85 °C	-40 ~ +85 °C	-55 ~ +125 °C
Coupling Style	Threaded	Push type	Push type	Threaded	Bayonet	Push-on lock
Features	Compact and light weight with rugged construction.	Easy push pull mating.	Unique kink legs for board pre-fixturing before soldering.	Environmental rugged construction for outdoor applications.	Two impedance options available.	Superior high frequency performance.



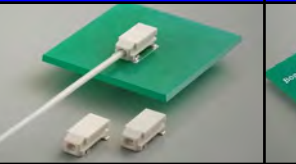

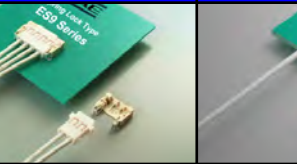
# LED Lighting Connectors

Series	ES3	ES3 (WF2)	ES3 (JF3)	ES5	ES9	ES10
Photo						
AWG	N/A	#22,24,26	#24,26 (solid)	#22,24,26	#22,24,26	#24,26
Pin Count	2	2	1	1	2, 4	1
Height	1.6mm	1.65mm	2.9mm	1.6mm	3mm	2.2mm
Locking	Friction	Latch	Friction	Latch	Friction	Friction
Durability	20 cycles	20 cycles	5 cycles	20 cycles	10 cycles	5 cycles
Current Rating	1.0A	2.0A	2.0A	4.0A	3.0, 4.0A	2.0A
Voltage Rating	200V	200V	N/A	N/A	300V	N/A
Operating Temperature	-40 ~ +105 °C	-40 ~ +105 °C	-40 ~ +105 °C	-40 ~ +105 °C	-40 ~ +105 °C	-40 ~ +105 °C
Features	Card edge connector that eliminates the need for wires to connect between boards.	Mechanical lock included for use in applications with vibration and shock.	Tapered insertion for easy mating. No harness assembly required.	Special lock structure that has a clear "click" feeling for secure mating.	Spring lock structure provides high retention strength.	Compact structure with no insulator allows design flexibility; Easy single wire cable insertion.

**ES3 Series (Card Edge type)**

Receptacle: **ES3B002WF1R1000**



**ES3-JF3 Series (Cable insertion type)**

Receptacle: **ES3S001JF3R3300**

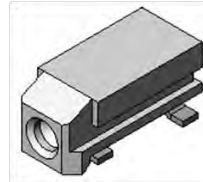

**ES3-WF2 Series (Board-to-Wire type)**

Receptacle: **ES3B002WF2R1000**

Housing: **ES3S002SZA**

Contact: **IL-Z-C1-A-7000**

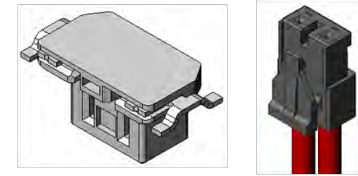

**ES5 Series**

Receptacle: **ES5S001JFA**

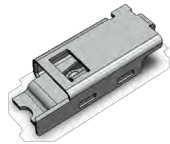

Cable Plug: **ES5P09K5FA**  
#24-26AWG

Cable Plug: **ES5P09K4F2**  
#22AWG

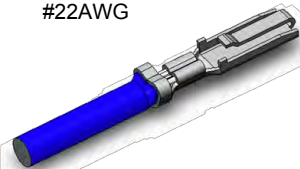

**ES9 Series**

Receptacle: **ES9P 00# VF1R1600**

No. of contacts:  
002: 2  
004: 4

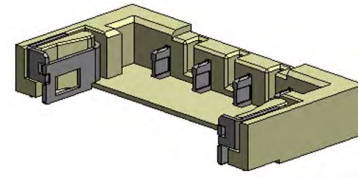

Plug (housing): **ES9S 00# SZA**

No. of contacts:  
002: 2  
004: 4

Contact: **ES9S06K4FA**

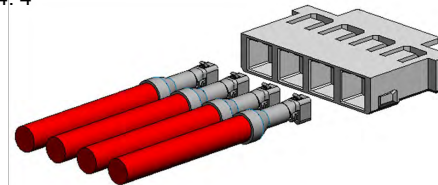



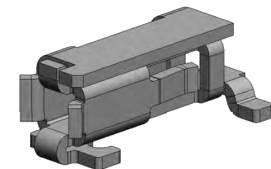

**ES10 Series**

Receptacle: **ES10S001JF1**



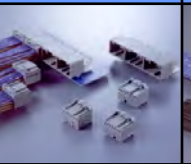
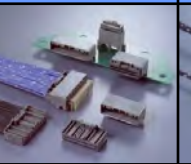
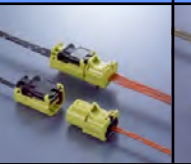
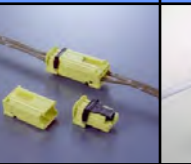
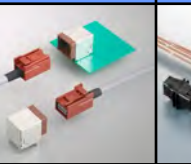





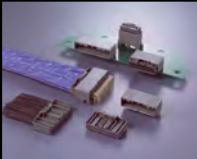
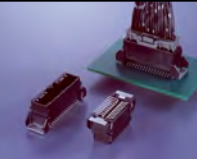

# Transportation 1

Series	IL-AG5	MX19	MX23A	MX31	MX34	MX36	MX37	MX39/MX45	MX44
Photo									
Pitch	2.5mm	2.5mm	2.5mm	Signal: 2.2mm Power: 3.2mm	2.2mm	2.5mm	2.2mm	2.2mm	3.5mm
Wire Size	AWG #22-18  AV,AVS,AVSS: 0.3 to 0.5mm <sup>2</sup> AVS, AVSS: 0.85mm <sup>2</sup>	AWG #22-20  CAVS: 0.3 to 0.5mm <sup>2</sup> AVSS: 0.5mm <sup>2</sup>	AWG #22-16  AVSS, AVS: 0.5 to 1.25mm <sup>2</sup>	Signal: AWG #22-20 Power: AWG #22-16  Signal: AVS, AVSS, AVX 0.3 to 0.5mm <sup>2</sup> Power: AVS, AVSS AVX 0.3 to 1.25mm <sup>2</sup>	AWG #22-20  AVSS: 0.3, 0.5mm <sup>2</sup> CHFUS: 0.22 to 0.35mm <sup>2</sup> , 0.5 to 0.75mm <sup>2</sup> CAN SD: 0.35mm <sup>2</sup>	AWG #20  AVSS 0.5, AVSS 0.5F, AVSSX 0.5f, TVSSX 0.5f	AWG #20  AVSS 0.5, AVSS 0.5F, AVSSX 0.5f, TVSSX 0.5f	AWG #28 Twin Ax	AWG #22-20  AVSS 0.3 to 0.5mm <sup>2</sup>
Pin Count	1 row: 4,5,6, 7,10 2 rows: 14,16, 18,22,30	2, 4	12, 18, 26, 34, 36,40	Pin: 70,98,104,135 Socket: 31,34,35	3,5,7,8,12,16, 20,24,28,32,36, 40	2, 4	4	4	2, 4, 6
Current Rating	3A	5A	3A	Signal: 2.2A Power: 5.7A	3A	3A	3A	500mA	3A
Operating Temperature	-40 ~ +85 °C	-40 ~ +85 °C	-40 ~ +125 °C	-40 ~ +85 °C	-40 ~ +85 °C	-40 ~ +105 °C	-40 ~ +105 °C	-40 ~ +85 °C	-40 ~ +125 °C
Application	Cable to Cable/ Board to Cable	Cable to Cable	Board to Cable	Board to Cable	Board to Cable	Cable to Cable	Cable to Cable	Cable to Cable/ Board to Cable	Board to Cable
Features	Mechanical lock system enabling complete mating. Secondary lock mechanism to ensure correct terminal retention. Simplified crimp type termination.	Waterproof. Mechanical lock system. Grommet seal. Terminals have low insertion force and stress dispersion. Rear cover protects the grommet from damage.	Waterproof. Low profile. Available in reverse mount type. Retainer detects incomplete insertion of socket contact.	Mechanical lock system with audible click. Socket side contact designed with secondary lock. Simplified crimp type termination.	Lightweight. Mating and unmating force less than 80N. Closed box socket contact increases mechanical strength. Preset retainer allows easy wire harness assembly.	Waterproof. Spring separates connectors if not correctly mated. Shorting contact eliminates static discharge. Retainer detects incomplete insertion of socket contact.	Mechanical complete mating method. Spring separates connector if not correctly mated. Shorting contact eliminates static discharge. Retainer detects incomplete insertion.	USB 2.0 compatible. Sold as a complete harness with USB standard receptacle.	Single contact waterproof. Compact size. Improved vibration resistance by vibration absorption function of rubber. Secondary lock mechanism.



# Transportation 2

Series	MX34			MX35	MX38	MX47	MX48	MX49	MX50/53
	Standard T/H	Straight SMT	Right Angle SMT						
Photo									
Pitch	2.2mm	2.2mm	2.2mm	N/A	2.0mm	2.5mm	2.0mm	2.0mm	1.5mm
Wire Size	AWG #22-20 AVSS: 0.3, 0.5mm <sup>2</sup> CHFUS: 0.22 to 0.75mm <sup>2</sup> CAN SD: 0.35mm <sup>2</sup>	AWG #22-20 AVSS: 0.3, 0.5mm <sup>2</sup> CHFUS: 0.22 to 0.75mm <sup>2</sup> CAN SD: 0.35mm <sup>2</sup>	AWG #22-20 AVSS: 0.3, 0.5mm <sup>2</sup> CHFUS: 0.22 to 0.75mm <sup>2</sup> CAN SD: 0.35mm <sup>2</sup>	N/A	AWG #28 (Twin Ax)	AWG #22-16 AVSS 0.3 to 1.25mm <sup>2</sup>	AWG #28 (Twin Ax)	Signal: AWG #26 (Twin Ax) Power: AWG #20	AWG #28 (Twin Ax)
Pin Count	3,5,7,8,12,16,20,24,28,32,36,40	12, 20, 32	8, 12, 20	1	2	39	2	4	19
Current Rating	3A	3A	3A	1A	—	3A	—	Signal: 0.5A	0.5A
Operating Temperature	-40 ~ +85 °C	-40 ~ +85 °C	-40 ~ +85 °C	-30 ~ +85 °C	-40 ~ +85 °C	-40 ~ +125 °C	-40 ~ +85 °C	-40 ~ +85 °C	-40 ~ +85 °C
Application	Board to Cable	Board to Cable	Board to Cable	Board to Cable	Board to Cable	Board to Cable	Board to Cable	Board to Cable	Cable to Cable/ Board to Cable
Features	Mechanical lock system enabling complete mating. Secondary lock mechanism to ensure correct terminal retention. Simplified crimp type termination. Thru hole terminals.	Vertical mount SMT header. Same features as standard MX34.	Horizontal mount SMT header. Same features as standard MX34.	Conforms to FAKRA standard. Frequency range of DC to 4GHz. Available as straight or right angle. Multiple keying options available.	Excellent in transmission of high-speed signals such as LVDS and GVIF. Different key options available	Waterproof. Different key option available. Retainer detects incomplete insertion of socket contact.	Excellent in transmission of high speed signals such as LVDS and GVIF. Different key options available. Extremely compact design.	Compatible with USB 2.0 signal speeds. Different key options available. Extremely compact design.	HDMI Type E compatible connector and harnesses. Cable mounted receptacle for mating with consumer HDMI cables is available.

T/H Pin header: **MX340##UF1**      Socket housing: **MX340##SF1**

U: Straight      1: 3-24 pos  
N: Angled      2: 28-40 pos

SMT Pin header: **MX34R##VF1 \***

V: Straight      Blank: tube  
H: Angled      T: tray

1: Straight  
4: Angled

Contacts	Hand Tool	Semi auto	Automatic
M34S75C4F1	CT150-2-MX34	350-MX34D-2	350-MX34B-3B
M34S75C4F2	CT150-1-MX34	350-MX34D-2	350-MX34B-3B
M34S75C4F3	N/A	350-MX34C-2	350-MX34C-3B
M34S75C4F4	N/A	350-MX34C-2	350-MX34C-3B

Pin header: **MX35 # 01 N P1**

N: angle  
T: straight

Different key code

Key Codes:

<u>Angle type</u>	<u>Straight type</u>
B: white	B: white
C: blue	C: blue
E: green	E: green
F: brown	F: brown
G: blue-gray	I: beige
H: violet	
K: yellow	

Board Mounting Receptacle: **MX48002NQ1**

Different key code: 1,2,3,4

**JAE will supply the complete mating harness designed to customer specifications.**

Board Mounting Receptacle: **MX38002FQ1**

Different key code: 1,2,3,4

Pin header: **MX38002NQ1**

**JAE will supply the complete mating harness designed to customer specifications.**

Board mounting receptacle: **MX49004 # Q 1**

N: T/H  
H: SMT

Different key code: 1,2 (T/H)  
1,2,3,4 (SMT)

**JAE will supply the complete mating harness designed to customer specifications.**

Socket housing: **MX47037SF1**

Key code: 1,2

Pin header: **MX47037NF1**

Front cap: **MX47037XF1**

Contacts	Wire size (AWG)	Hand tool	Semi Auto Applicator
M47S65H2FA	#22-20	CT160-3-MX47	3502-MX47-2
M47S65H3FA	#18	CT160-3B-MX47	3502-MX47-2
M47S65H4FA	#16	CT160-3C-MX47	3502-MX47-2

Board mounting receptacle: **MX50019NQ1**

**JAE will supply the complete mating harness designed to customer specifications.**

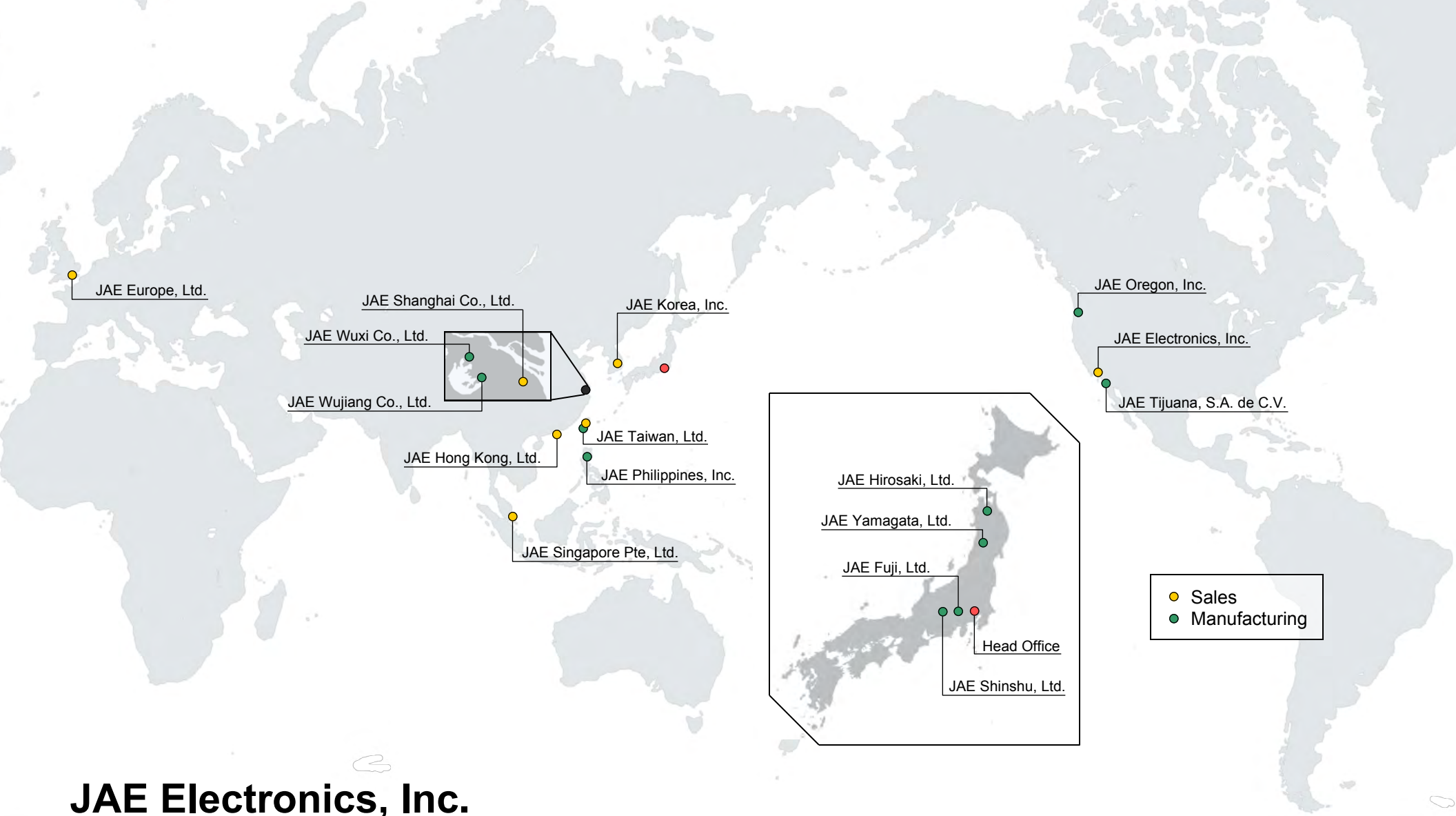

# JAE Electronics, Inc.

142 Technology Drive, Suite 100  
Irvine, CA 92618

Telephone: (949) 753-2600

Fax: (949) 753-2699

[www.JAE.com](http://www.JAE.com)

\*No part of this publication may be reproduced or distributed in any means, or stored in a data based or retrieval system, without the prior written permission of JAE Electronics, Inc.

Copyright © 2014 JAE Electronics, Inc.

Technology to Inspire Innovation

